

# ALICE

## Assembly instruction

1/12

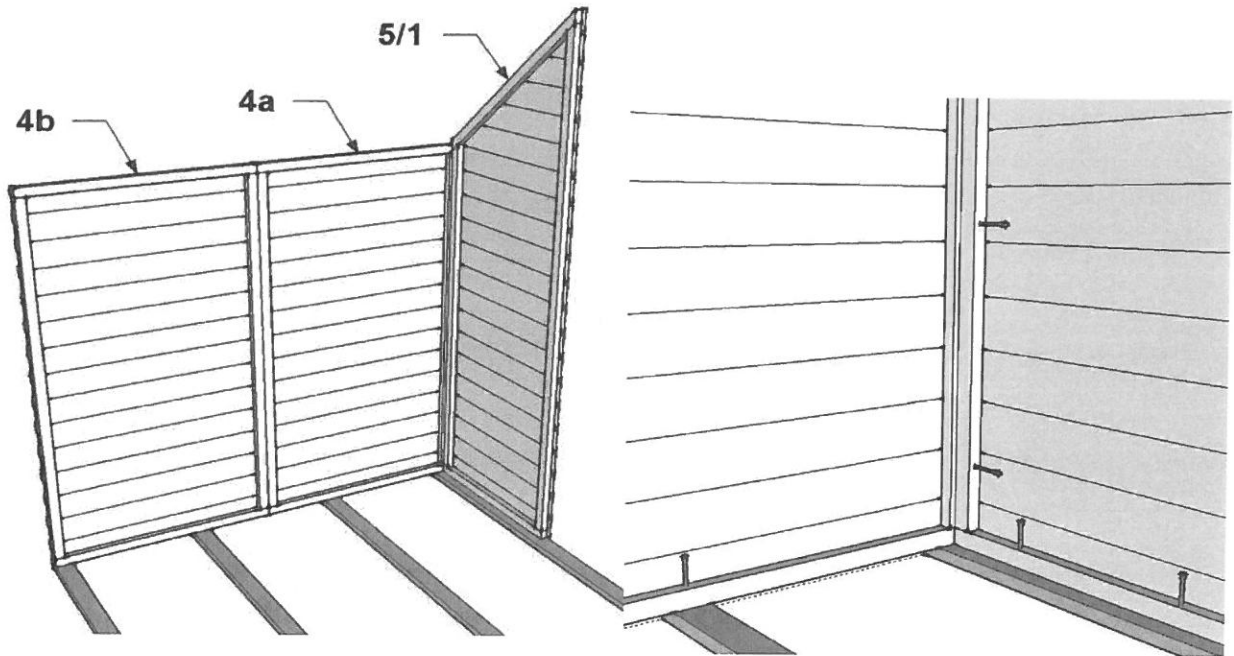
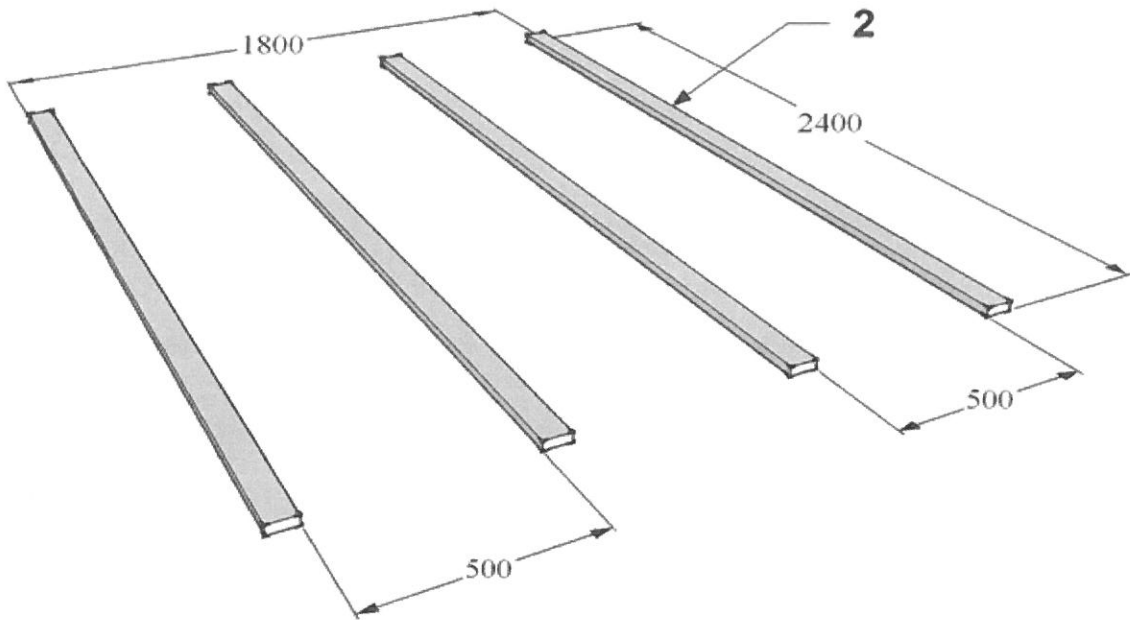

5/1	+	4a	+	4b	4 x 55	6
5/1	4a	4b	+	base	4 x 55	4

# ALICE

## Assembly instruction

2/12

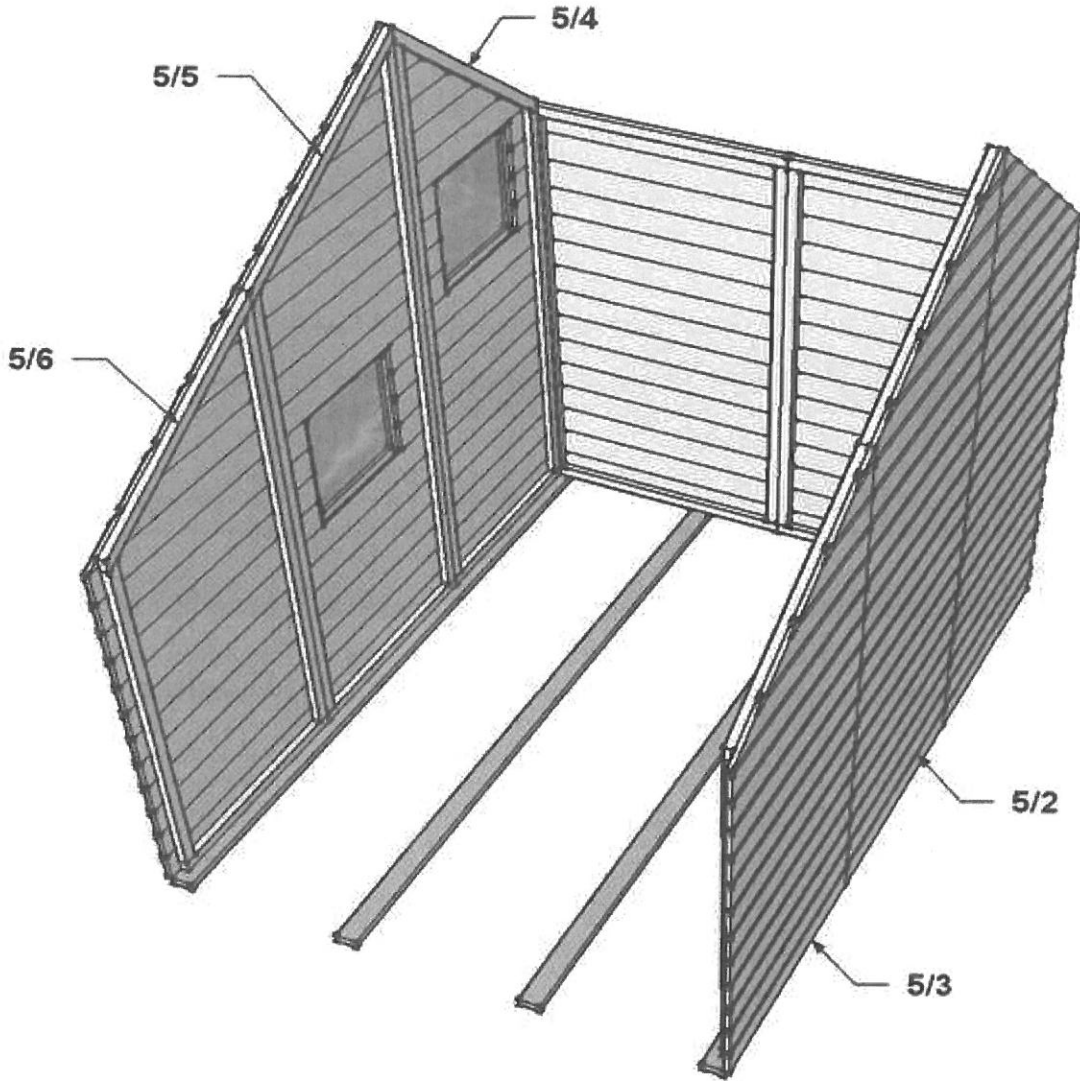

+	5/4	+	5/5	+	5/6	+	4 x 55	17
	+	5/2	+	5/3				
5/4	5/5	5/6	5/2	5/3	+	base	4 x 55	10

**ALICE**  
**Assembly instruction**

3/12

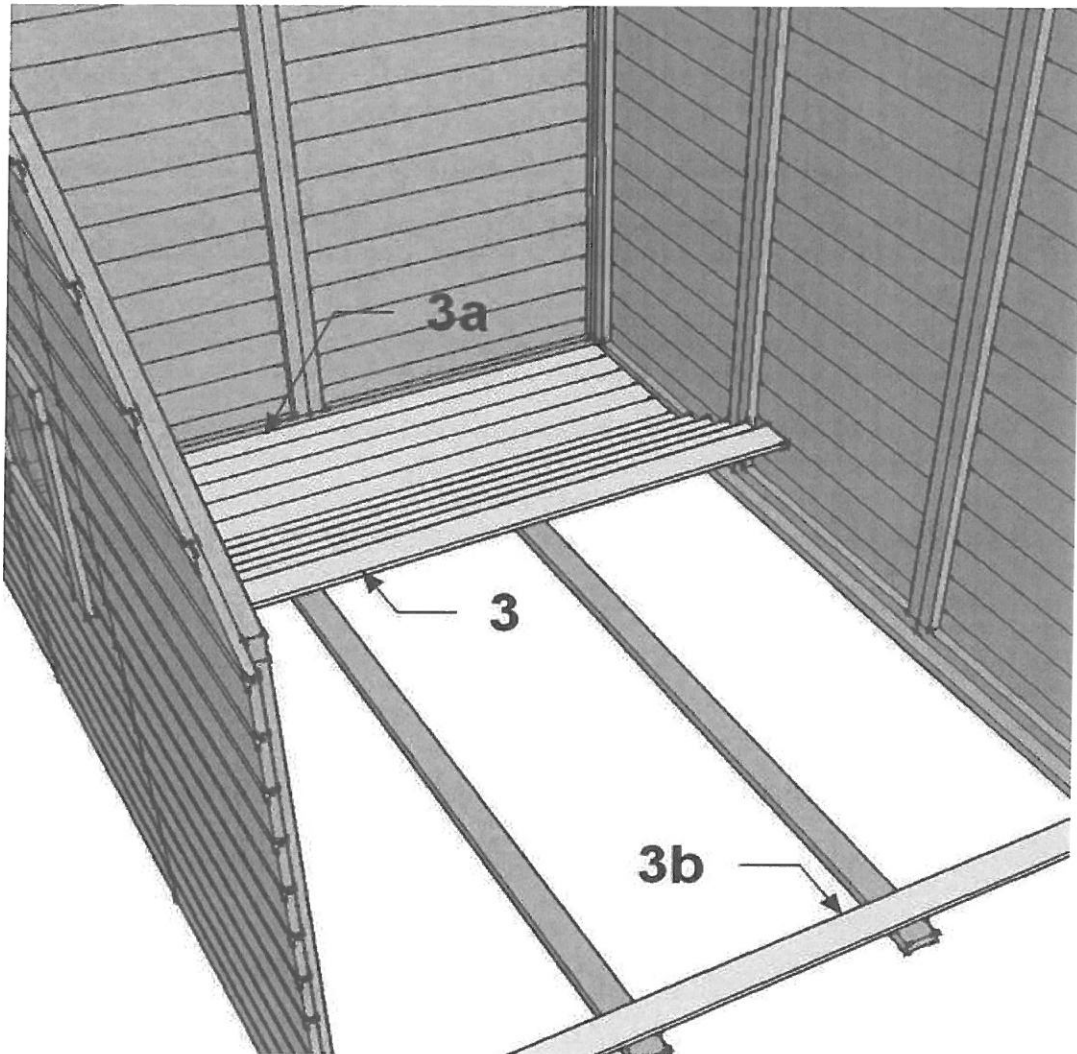

3a	+	3	+	3b	2 x 40	112
----	---	---	---	----	--------	-----

# ALICE

## Assembly instruction

4/12

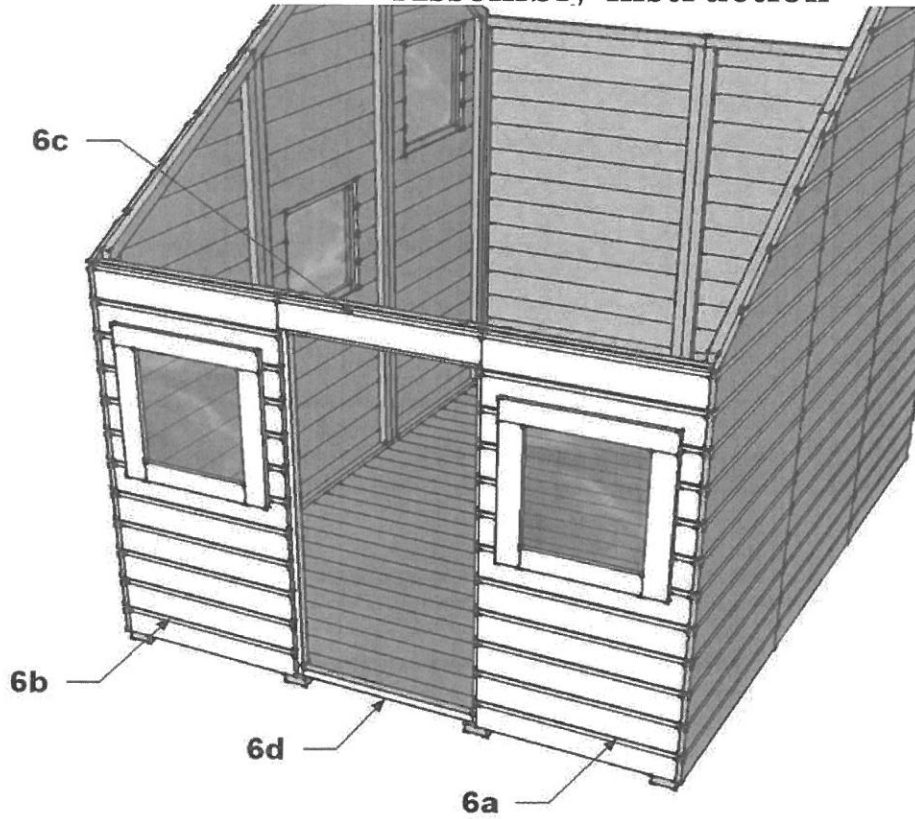

<b>6a</b>	+	<b>6b</b>	+	<b>6c</b>	+	<b>6d</b>	4 x 55	<b>8</b>
<b>6a</b>		<b>6b</b>		<b>6d</b>	+	base	4 x 55	<b>6</b>

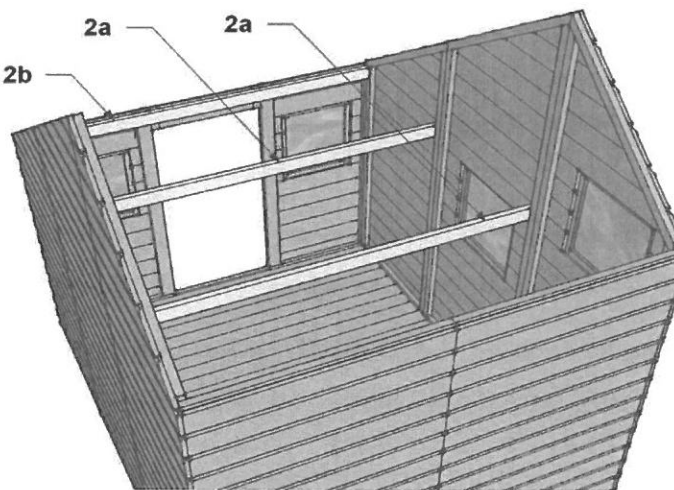
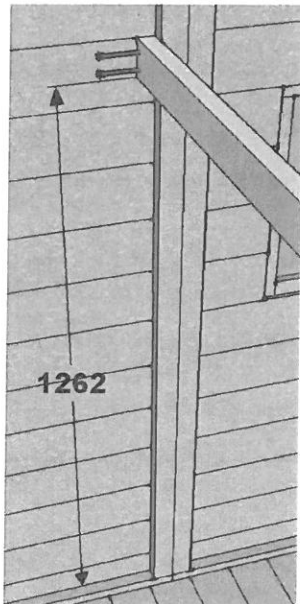

<b>2a</b>	+	<b>2b</b>	4 x 55	<b>14</b>
-----------	---	-----------	--------	-----------

# ALICE

## Assembly instruction

5/12

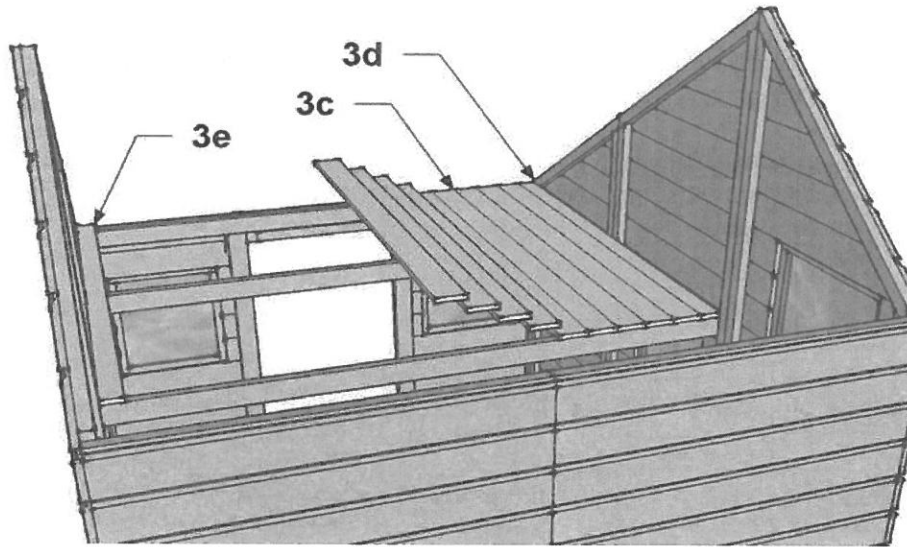

3d	+	3c	+	3e	2 x 40	66
----	---	----	---	----	--------	----

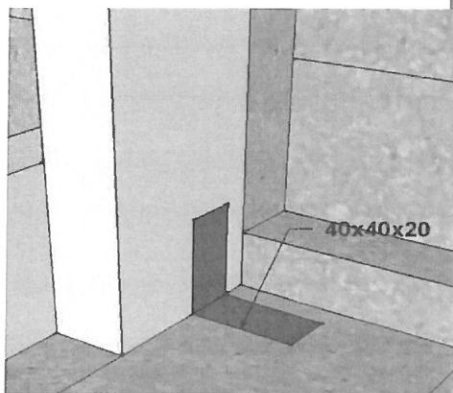
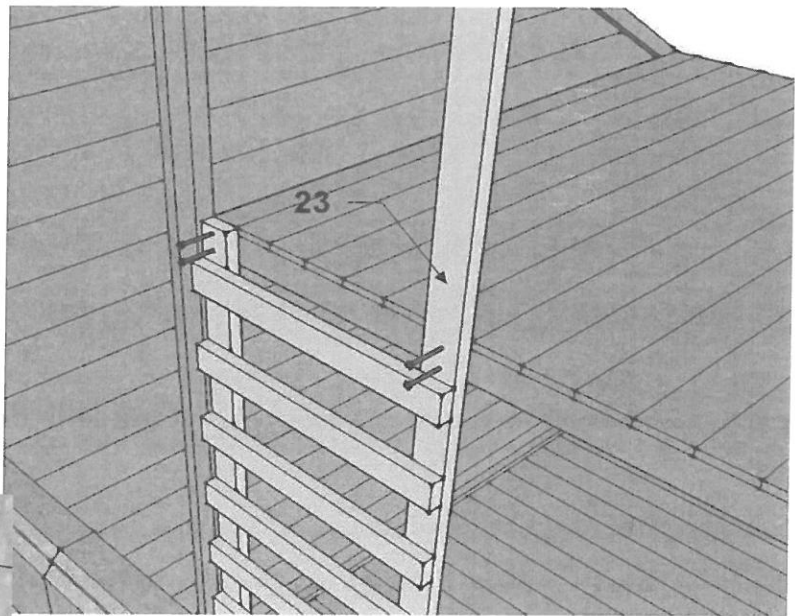

+ 23

3,5 x 45	4
40 x 40 x 20	2
3,5 x 35	8

# ALICE

## Assembly instruction

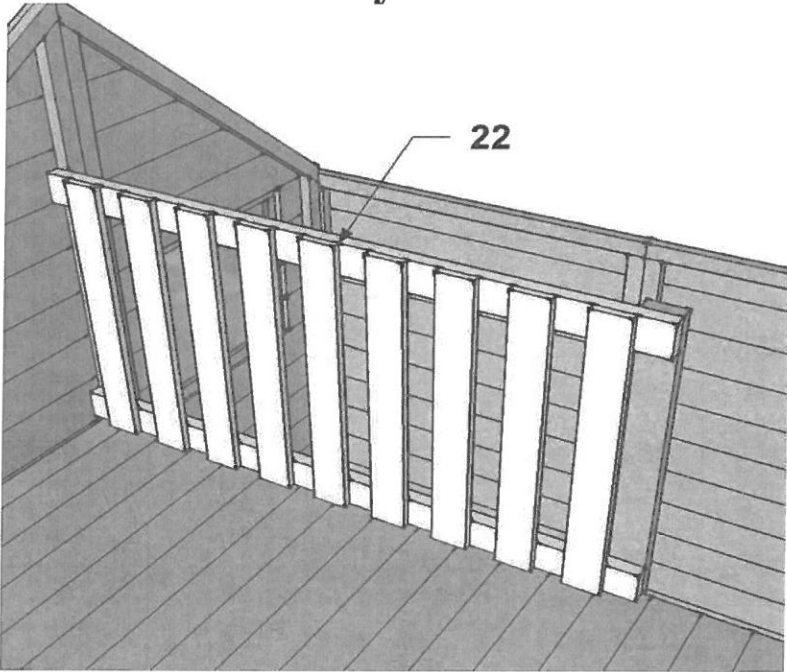

+	<b>22</b>	<b>3,5 x 45</b>	<b>8</b>
---	-----------	-----------------	----------

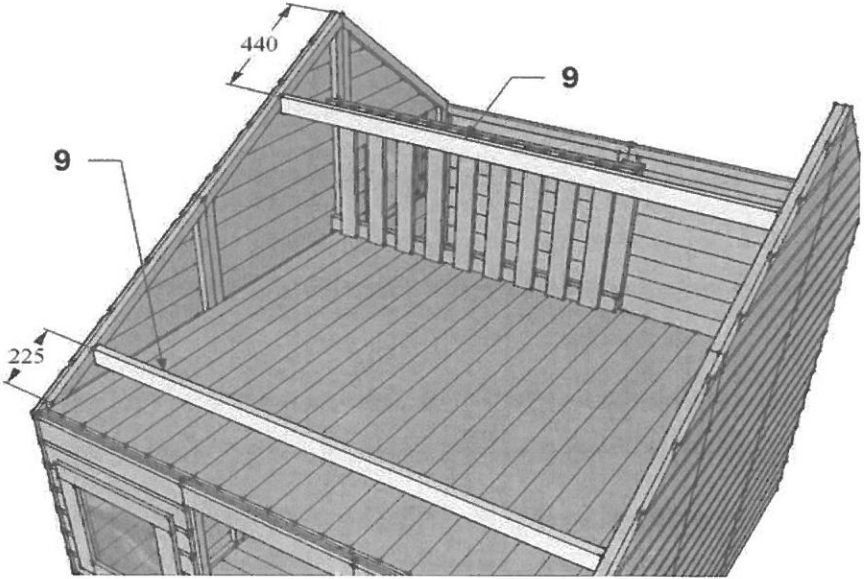
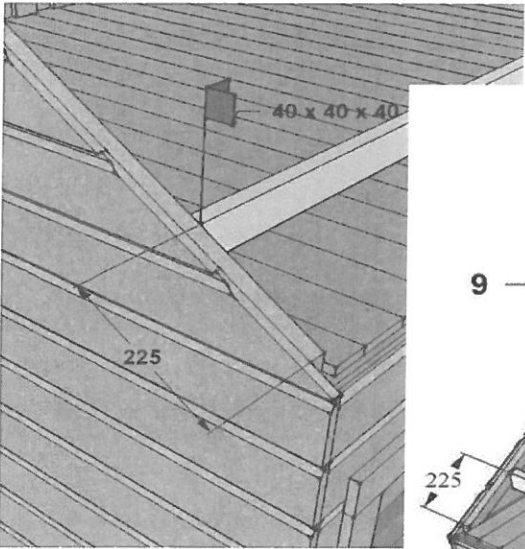

+	<b>9</b>	<b>40 x 40 x 40</b>	<b>4</b>
		<b>3,5 x 30</b>	<b>24</b>



# ALICE

## Assembly instruction

7/12

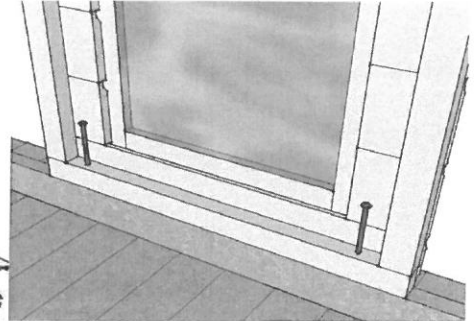
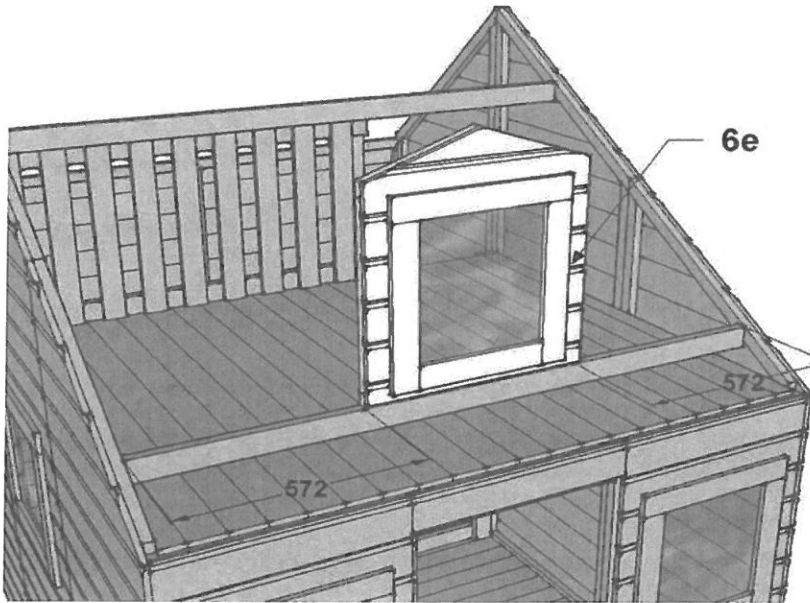

+ 6e

4 x 55

3

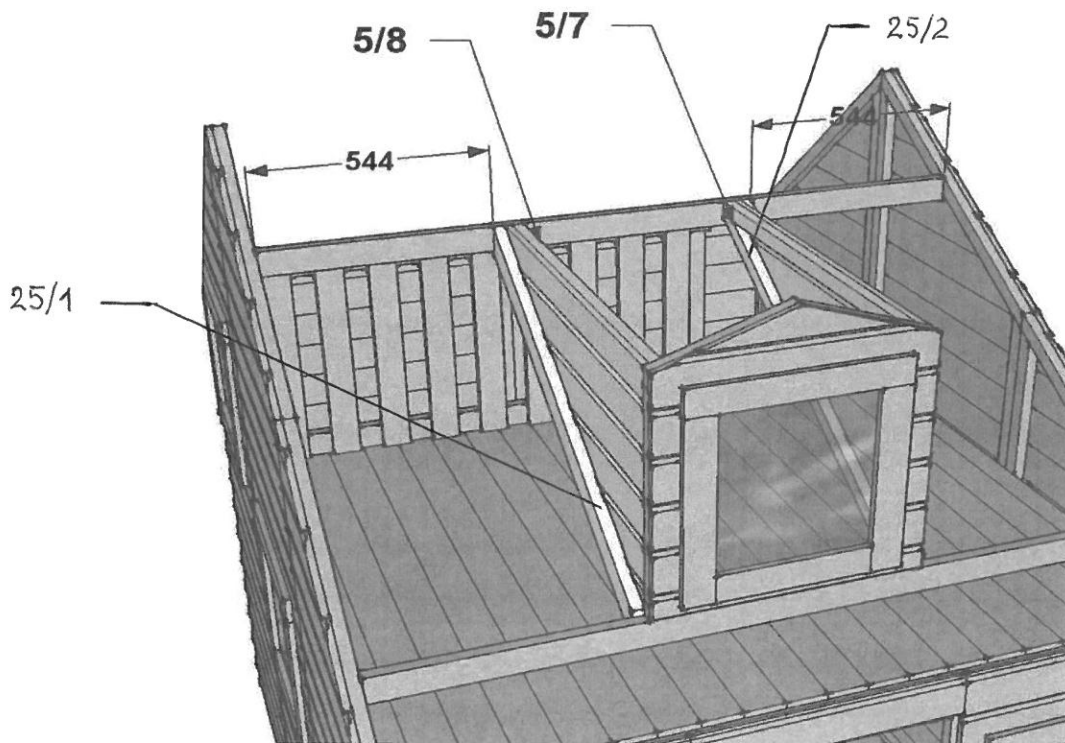

+ 5/7 + 5/8

4 x 55

8

4 x 55

4

# ALICE

## Assembly instruction

8/12

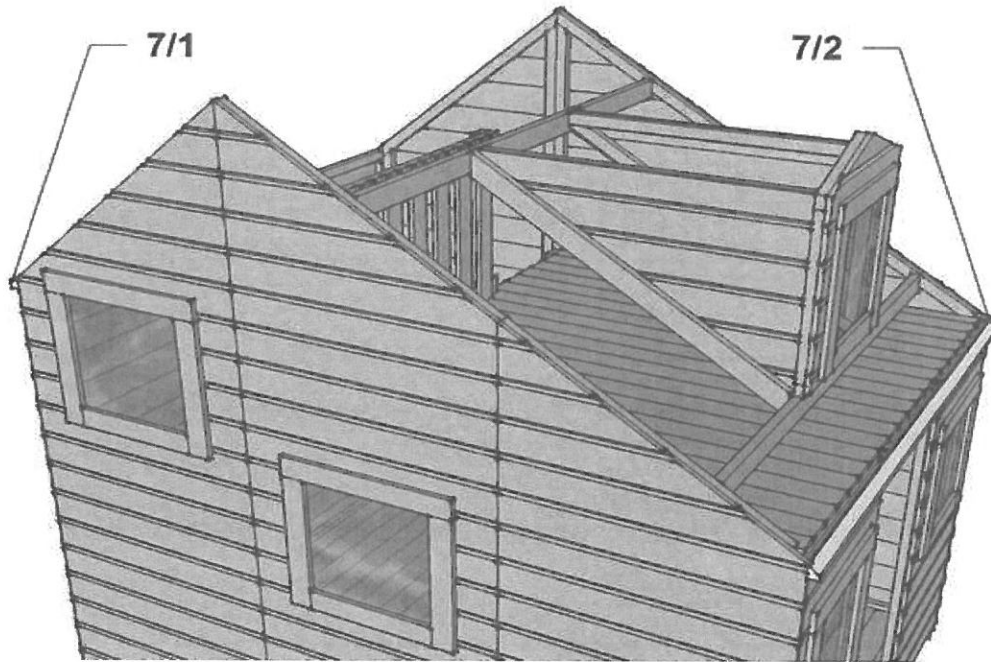

+	7/1	+	7/2	3,5 x 45	9
---	-----	---	-----	----------	---

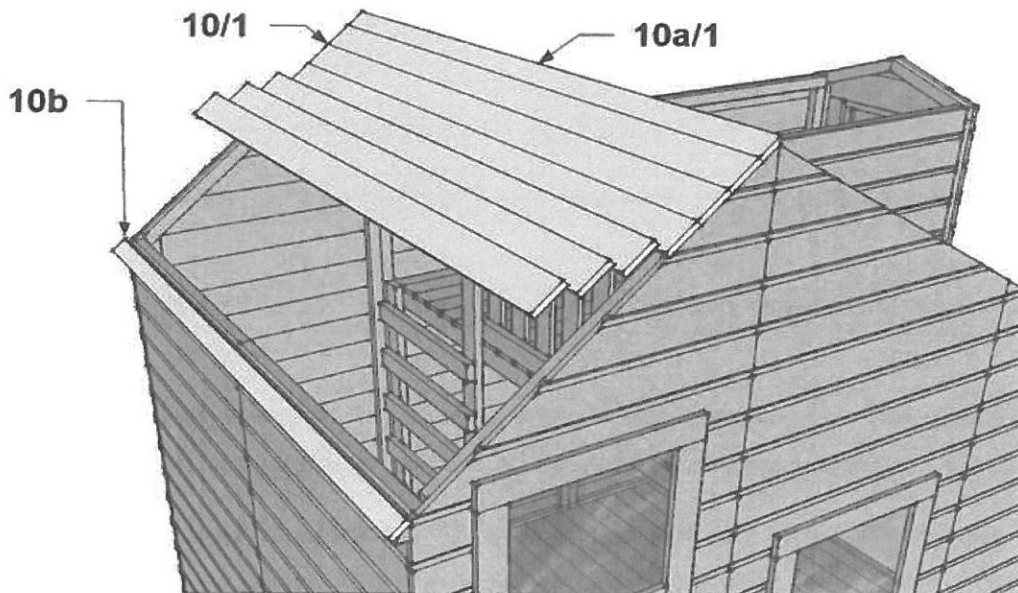

10a/1	+	10/1	+	10b	2 x 40	34
-------	---	------	---	-----	--------	----

# ALICE

## Assembly instruction

9/12

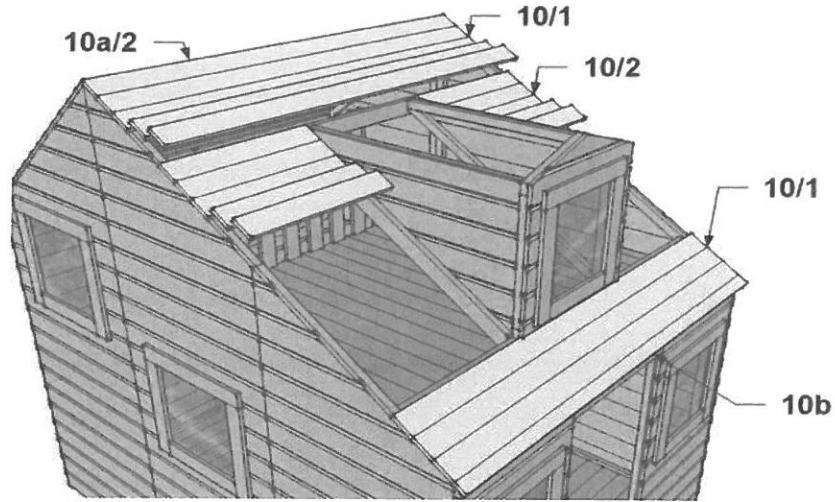

10a/2	+	10/1	+	10/2	+	10b	2 x 40	86
-------	---	------	---	------	---	-----	--------	----

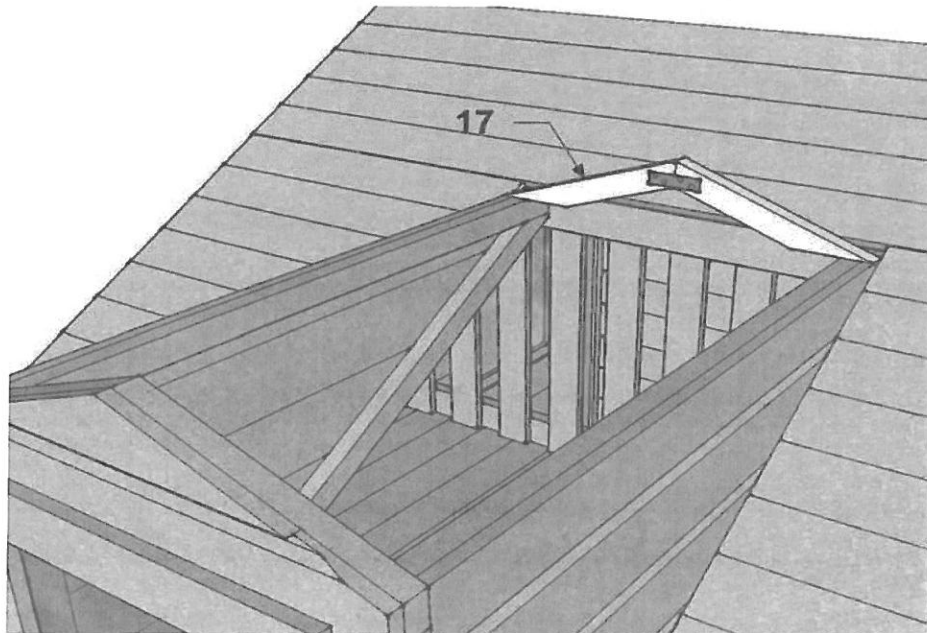

+	17	3,5 x 45	4
---	----	----------	---

# ALICE

## Assembly instruction

10/12

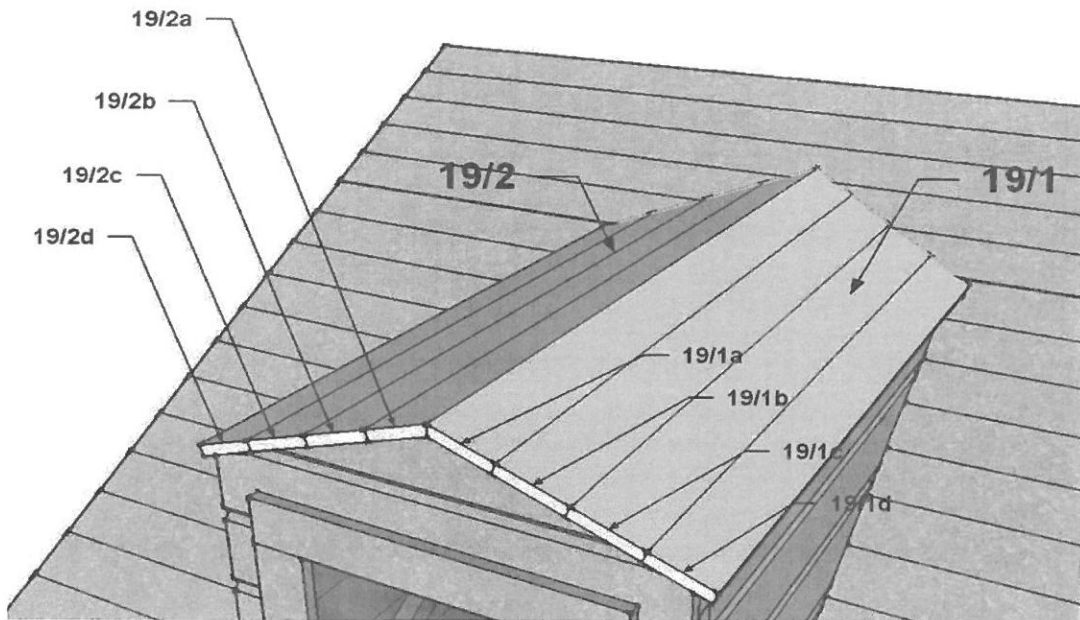

+	<b>19/1</b>	+	<b>19/2</b>		<b>2,0 x 40</b>	<b>32</b>
---	-------------	---	-------------	--	-----------------	-----------

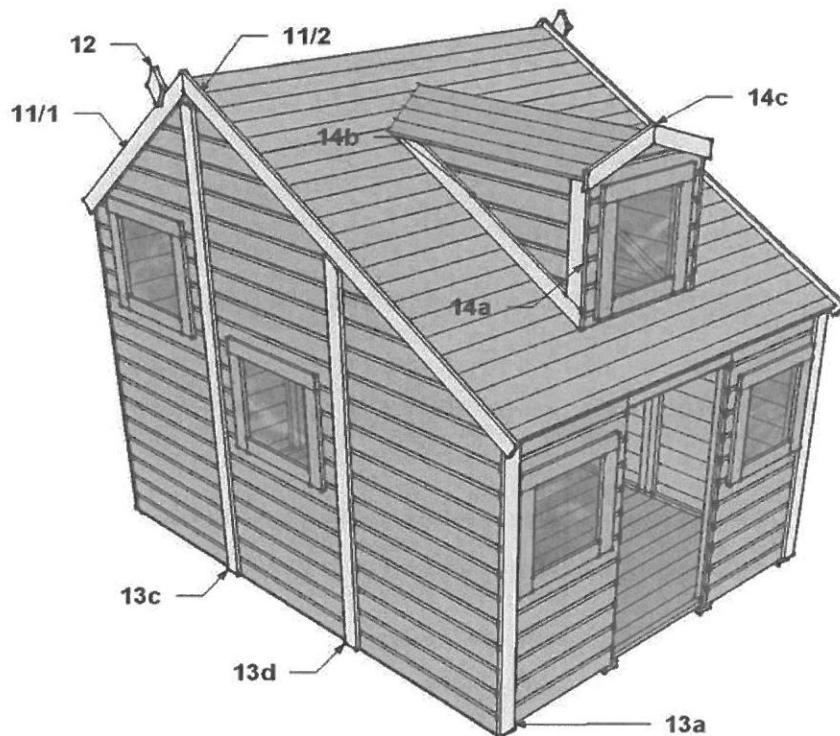

+	<b>11/1</b>	+	<b>11/2</b>	+	<b>12</b>	+			
<b>14a</b>	+	<b>14b</b>	+	<b>14c</b>	+	<b>13a</b>		<b>3,5 x 35</b>	<b>40</b>

# ALICE

## Assembly instruction

11/12

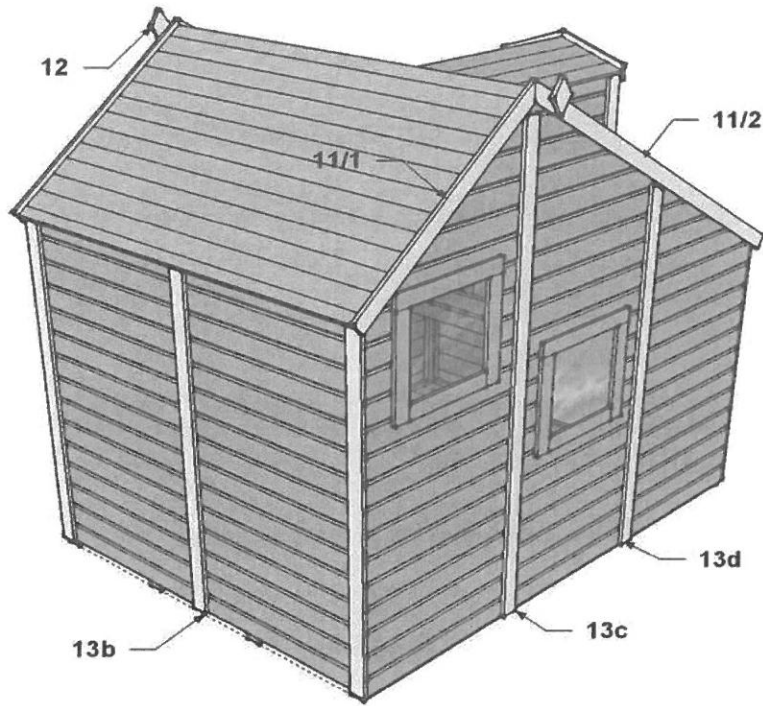

+ **13b** + **13c** + **13d**

<b>3,5 x 35</b>	<b>23</b>
-----------------	-----------

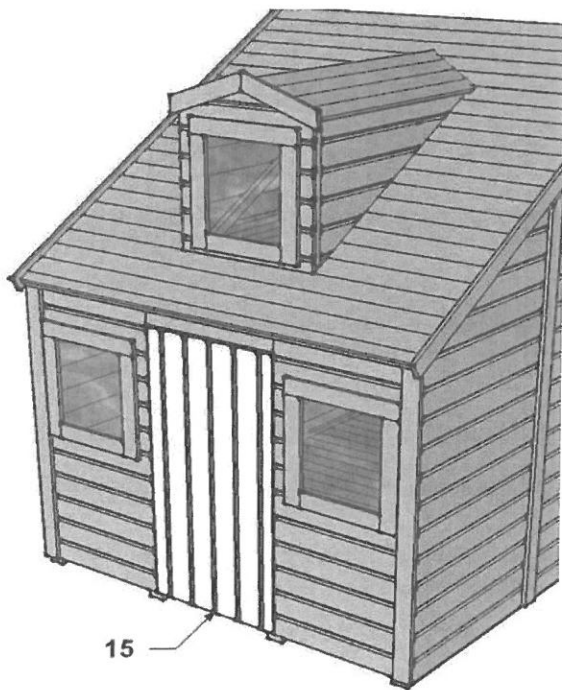

+ **15**

<b>3,5 x 35</b>	<b>6</b>
-----------------	----------





# ALICE

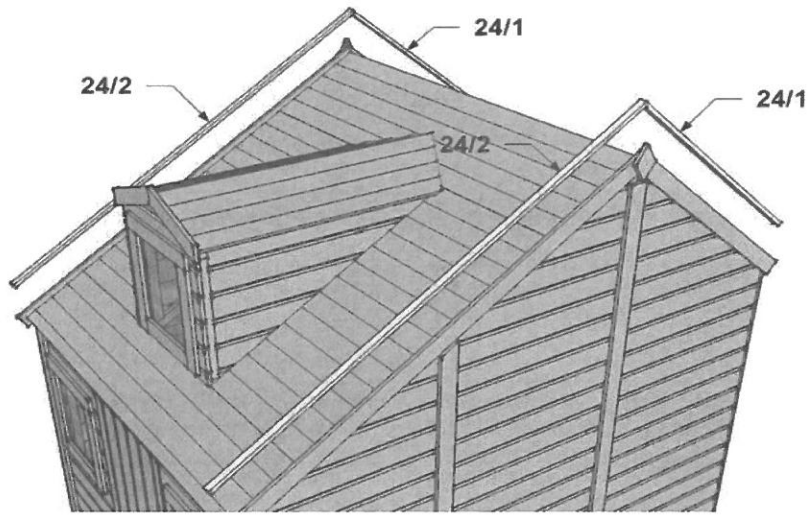

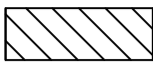

## Assembly instruction

12/12



+	<b>roofing</b>		
+	<b>24/1</b>	+	<b>24/2</b>
		+	<b>16</b>
		<b>3,5 x 30</b>	<b>20</b>
		<b>2,5 x 16</b>	<b>20</b>
		<i>MUNTIN BARS</i>	

Pos	Specification Alice 240x180		Pcs	Dimension (mm)	Length (mm)
2	Foundation beam		4	28x58	2400
2a	Balcony beam (girder)		3	28x58	1170
3	Floor board		20	16x113	1713
3a	Floor board (first)		1	16x113	1713
3b	Floor board (last)	 ✓	1	16x113	1713
3c	Balcony's floor board		18	18x88	1534
3d	Balcony's floor board (first)		1	18x88	1534
3e	Balcony's floor board (last)	 ✓	1	18x88	1534
4a	Back wall element (right)		1	857x1675	
4b	Back wall element (left)		1	857x1675	
5/1	Side wall element (right), rear		1	800x1675/2373	
5/2	Side wall element (right), middle		1	800x1865/2373	
5/3	Side wall element (right), anterior		1	800x1360/1865	
5/4	Side wall element (left), rear; with window		1	800x1675/2373	
5/5	Side wall element (left), middle; with window		1	800x1865/2373	
5/6	Side wall element (left), anterior		1	800x1373/1865	
5/7	Side wall element (right), dormer (triangular)		1	970x643	
5/8	Side wall element (left), dormer (triangular)		1	970x643	
6a	Front wall element (right); with window		1	600x1360	
6b	Front wall element (left); with window		1	600x1360	
6c	Front wall connection element		1	600x113	
6d	Front wall lower element		1	16x28x600	
6e	Front wall element, dormer; with window		1	600x740/630	

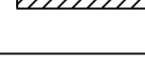
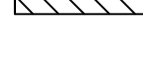
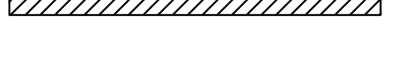
Pos	Specification Alice 240x180			Pcs	Dimension (mm)	Length (mm)	
7/1	Roof eaves beam, back		40°	1	28x17/40	1800	
7/2	Roof eaves beam, front		32°	1	28x23/40	1800	
9	Support beam, dormer			2	28x58	1713	
10/1	Roof board			15	16x113	1800	
10/1a	Roof board (under the dormer) with cut			1	16x113	1800	
10/2	Roof board			20	16x113	616	
10a/1	Roof board (back), first		40°	1	16x113	1800	
10a/2	Roof board (front), first		32°	1	16x113	1800	
10b	Roof board, last		✓	2	16x113	1800	
11/1	Gable board (back)			40°	2	18x58	1130
11/2	Gable board (front)			32°	2	18x58	1955
12	Diamond (for gable)			3			
13a	Front wall cover slat			2	18x58	1333	
13b	Back wall cover slat			3	18x58	1635	
13c	Side wall rear cover slat			2	18x58	2320	
13d	Side wall front cover slat			32°	2	18x58	1835
14a	Dormer front edge cover slat			32°	2	18x58	560
14b	Dormer lower edge cover slat			32°/58°	2	18x58	1160
14c	Gable board (Dormer)			20°	2	18x58	370
15	Door 580x1225			1	580x1225		
16	Handle			1			
17	Support for dormer's roof (rafter)			20°/70°	2	28x68	319
19/1a	Roof board (Dormer), right			30°/45°, 20°	1	16x80	1240
19/1b	Roof board (Dormer), right			30°/45°	1	16x113	1197



Pos	Specification Alice 240x180		Pcs	Dimension (mm)	Length (mm)
19/1c	Roof board (Dormer), right	 30°/45°	1	16x113	1130
19/1d	Roof board (Dormer), right	 30°/45°	1	16x60	1064
19/2a	Roof board (Dormer), left	 30°/45°, 20°	1	16x80	1240
19/2b	Roof board (Dormer), left	 30°/45°	1	16x113	1197
19/2c	Roof board (Dormer), left	 30°/45°	1	16x113	1130
19/2d	Roof board (Dormer), left	 30°/45°	1	16x60	1064
22	Balcony's fence		1	630x1240	
23	Ladder		1	1375/2020x588	
24/1	Gable slat	 40°	2	18x40	1130
24/2	Gable slat	 32°	2	18x40	1955
25/1	Support beam, dormer	 32°/32°	1	28x58	1200
25/2	Support beam, dormer	 32°/32°	1	28x58	1200
	Muntin bars			5 sets (a' 2pcs)	
	Metal angle 40x40x20	(23)	2		
	Metal angle 40x40x40	(9)	4		
	Screws 4x60	(5,4a,4b,6a-e,2a,2b)	80		
	Screws 3,5x45	(23,22,7/1,7/2,17)	25		
	Screws 3,5x35	(23,11,12,13a-d,14a-c,15)	77		
	Screws 3x30	(9,24/1,24/2)	44		
	Screws 2,5x16	(16, Muntin bars)	20		
	Nails 2x40	(3,3a-e,10,19/1,19/2)	330		
	Roofing felt			1,9m-4stck.	7,6m
	Nails 2,0x18	 Roofing felt	152		
	✓ - to be cut to length at building site!				